

**DEWALT**®

**XR FLEX  
VOLT™  
LI-ION**

**[www.DEWALT.com](http://www.DEWALT.com)**

**DCC1054**



Fig. A

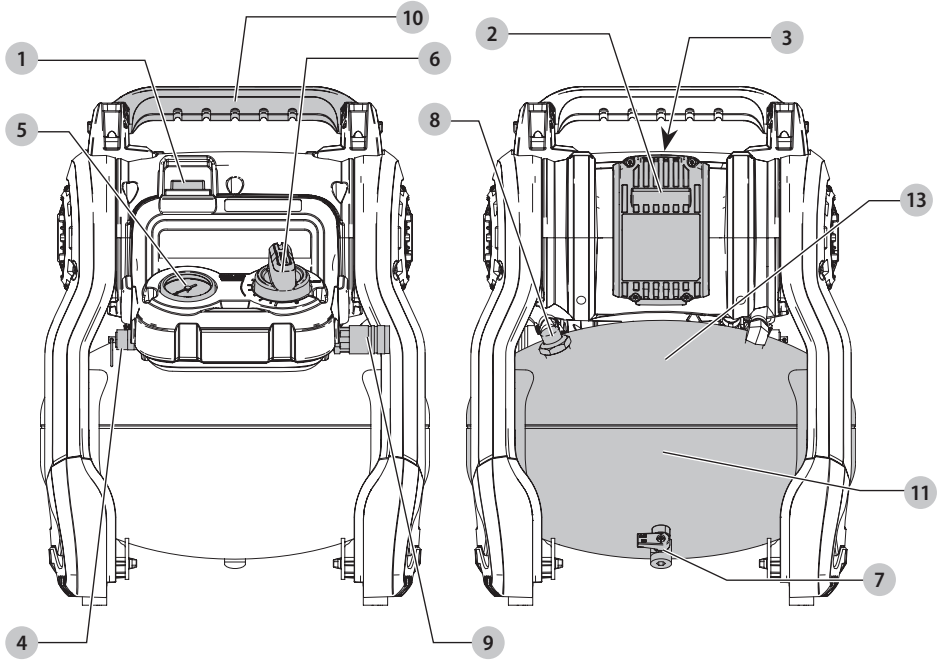

Fig. B

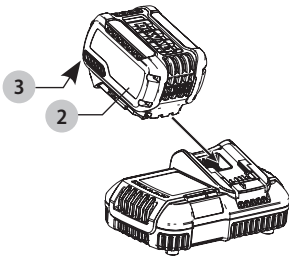

Fig. C

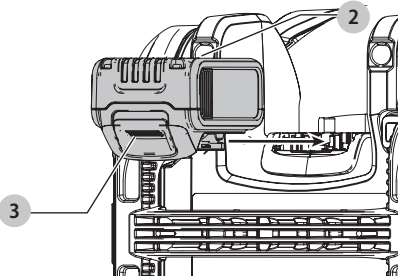

Fig. D

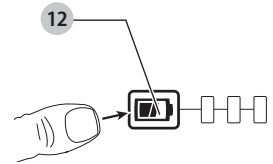

Fig. E

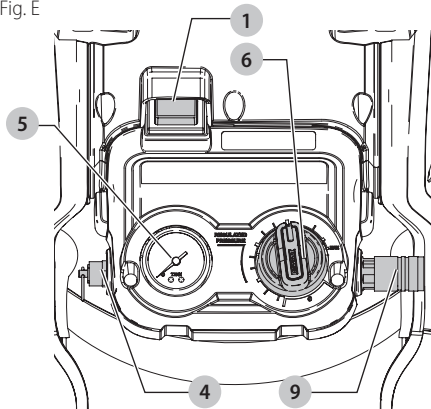
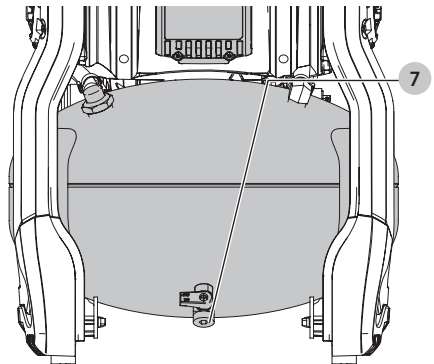

Fig. F



# 54V 10L CORDLESS AIR COMPRESSOR

## DCC1054

### Congratulations!

You have chosen a DeWALT tool. Years of experience, thorough product development and innovation make DeWALT one of the most reliable partners for professional power tool users.

### Technical Data

		DCC1054
Voltage	V <sub>DC</sub>	54
Type		1
Battery type		Li-Ion
Air tank capacity	Liters	10
Approx. cut-in pressure	BAR	7.2
Approx. cut-out pressure	BAR	9.3
Air displacement	l/min	48
Air delivery at 7 BAR	l/min	31
Fuse type		Time delay
Regulated pressure rating (approximate)	BAR	0–9.3
Motor revolutions per minute		3400
Quick connect type		Universal EU 1/4" quick coupling
Pump type		Oil-less
Weight (without battery pack)	kg	11.0
Noise values according to EN1012-1		
L <sub>PA</sub> (emission sound pressure level)	dB(A)	79
L <sub>WA</sub> (sound power level)	dB(A)	92
K (uncertainty for the given sound level)	dB(A)	3

The vibration emission level given in this information sheet has been measured in accordance with a standardised test given in EN1012-1 and may be used to compare one tool with another. It may be used for a preliminary assessment of exposure.

### EC-Declaration of Conformity

#### Machinery Directive



#### 54V 10L Cordless Air Compressor DCC1054

DeWALT declares that these products described under **Technical Data** are in compliance with:

2006/42/EC, EN1012-1:2010, EN 60204-1:2006/A1:2009.

2000/14/EC, Compressors, P<15kW,

Annex VII, Deutsche Prüf- und Zertifizierungsstelle für Land- und Forsttechnik, Spremberger Straße 1, 64823 Groß-Umstadt, Notified Body ID No.: 0363.

Level of sound power according to 2000/14/EC

(Article 12, Annex III, No. 9:)

L<sub>WA</sub> (measured sound power level) dB 91

L<sub>WA</sub> (guaranteed sound power level) dB 92

These products also comply with Directive 2014/30/EU, 2014/29/EU, and 2011/65/EU. For more information, please contact DeWALT at the following address or refer to the back of the manual.

The undersigned is responsible for compilation of the technical file and makes this declaration on behalf of DeWALT.

Markus Rompel  
Director Engineering  
DeWALT, Richard-Klinger-Straße 11,  
D-65510, Idstein, Germany  
20.11.2017



**WARNING:** To reduce the risk of injury, read the instruction manual.

### Definitions: Safety Guidelines

The definitions below describe the level of severity for each signal word. Please read the manual and pay attention to these symbols.



**DANGER:** Indicates an imminently hazardous situation which, if not avoided, **will** result in **death or serious injury**.



**WARNING:** Indicates a potentially hazardous situation which, if not avoided, **could** result in **death or serious injury**.



**CAUTION:** Indicates a potentially hazardous situation which, if not avoided, **may** result in **minor or moderate injury**.

**NOTICE:** Indicates a practice **not related to personal injury** which, if not avoided, **may** result in **property damage**.



Denotes risk of electric shock.



Denotes risk of fire.

### SAFETY INSTRUCTIONS

#### Important Safety Instructions for Use of the Compressor



**WARNING: DEATH OR SERIOUS BODILY INJURY COULD RESULT FROM IMPROPER OR UNSAFE USE OF COMPRESSOR. TO AVOID THESE RISKS, FOLLOW THESE BASIC SAFETY INSTRUCTIONS.**

Batteries				Chargers/Charge Times (Minutes)					
Cat #	V <sub>oc</sub>	Ah	Weight (kg)	DCB107	DCB113	DCB115	DCB118	DCB132	DCB119
DCB546	18/54	6.0/2.0	1.05	270	140	90	60	90	X
DCB547	18/54	9.0/3.0	1.25	420	220	140	85	140	X
DCB181	18	1.5	0.35	70	35	22	22	22	45
DCB182	18	4.0	0.61	185	100	60	60	60	120
DCB183/B	18	2.0	0.40	90	50	30	30	30	60
DCB184/B	18	5.0	0.62	240	120	75	75	75	150
DCB185	18	1.3	0.35	60	30	22	22	22	X
DCB187	18	3.0	0.48	140	70	45	45	45	90

## READ ALL INSTRUCTIONS

- NEVER TOUCH MOVING PARTS.** Never place your hands, fingers or other body parts near the compressor's moving parts.
- NEVER OPERATE WITHOUT ALL GUARDS IN PLACE** Never operate this compressor without all guards or safety features in place and in proper working order. If maintenance or servicing requires the removal of a guard or safety features, be sure to replace the guards or safety feature before resuming operation of the compressor.
- ALWAYS WEAR EYE PROTECTION. Always wear safety goggles or equivalent eye protection.** Compressed air must never be aimed at anyone or any part of the body.
- PROTECT YOURSELF AGAINST ELECTRIC SHOCK. Prevent body contact with grounded surfaces such as pipes, radiators, ranges and refrigeration enclosures. Never operate the compressor in damp or wet locations. Never leave the compressor exposed to adverse weather conditions.**
- DISCONNECT THE COMPRESSOR WHEN NOT IN USE.** Always disconnect the compressor from the power source and remove the compressed air from the air tank before servicing, inspecting, maintaining, cleaning, replacing or checking any parts.
- AVOID UNINTENTIONAL STARTING. Do not transport the compressor over long distances, in a vehicle or in potentially dangerous situations, for example, on a ladder or scaffold while it is connected to its power source or when the air tank is filled with compressed air.** Be sure the auto ON/OFF switch is in the OFF position before connecting the compressor to its power source.
- STORE COMPRESSOR PROPERLY. When not in use, the compressor should be stored in dry place. Keep out of reach of children. Lock-out the storage area.**
- KEEP WORK AREA CLEAN Cluttered areas invite injuries.** Clear all work areas of unnecessary tools, debris, furniture etc.
- KEEP CHILDREN AWAY. Do not let visitors contact compressor extension cord.** All visitors should be kept safely away from work area.
- DRESS PROPERLY. Do not wear loose clothing or jewellery. They can be caught in moving parts.** Wear protective hair covering to contain long hair.
- STAY ALERT. Watch what you are doing. Use common sense. Do not operate compressor when you are tired.** Compressor should never be used by you if you are under the influence of alcohol, drugs or medication that makes you drowsy.
- CHECK FOR DAMAGED PARTS AND AIR LEAKS. Before further use of the compressor, carefully check the guard and other parts for damage to make sure that it will operate properly and perform its intended function. Check for alignment of moving parts, binding of moving parts, breakage of parts, mounting, air leak, and any other conditions that may affect its operation. A guard or other part that is damaged should be properly repaired or replaced by an authorized service centre unless otherwise indicated elsewhere in this Instruction Manual. Have defective pressure switches replaced by authorized service centre. Do not use compressor if switch does not turn it on and off. Never attempt to repair a leaking or damaged air tank. Replace tank immediately at an authorized service centre.**
- NEVER USE COMPRESSOR FOR APPLICATIONS OTHER THAN THOSE SPECIFIED. Never use compressor for applications other than those specified in the Instruction Manual. Never use compressed air for breathing or respiration. Never stand on the compressor.**
- HANDLE COMPRESSOR CORRECTLY. Operate the compressor according to the instructions provided herein. Never allow the compressor to be operated by children, individuals unfamiliar with its operation or unauthorised personnel.**
- KEEP ALL SCREWS, BOLTS AND COVERS TIGHTLY IN PLACE. Keep all screws, bolts, and plates tightly mounted. Check their conditions periodically.**
- KEEP MOTOR AIR VENT CLEAN The motor air vent must be kept clean so that air can freely flow at all times. Check for dust build-up frequently.**
- OPERATE COMPRESSOR AT THE RATED VOLTAGE. Operate the compressor at voltages specified on their nameplates. If using the compressor at a higher voltage than the rated voltage, it will result in abnormally fast motor revolution and may damage the unit and burn out the motor.**
- NEVER USE A COMPRESSOR WHICH IS DEFECTIVE OR OPERATING ABNORMALLY. If the compressor appears to**

be operating unusually, making strange noises, or otherwise appears defective, stop using it immediately and arrange for repairs by an authorized service centre.

19. **DO NOT WIPE PLASTIC PARTS WITH SOLVENT.** Solvents such as gasoline, thinner, benzene, carbon tetrachloride, and alcohol may damage and crack plastic parts. Do not wipe them with such solvents. Wipe plastic parts with a soft cloth lightly dampened with soapy water and dry thoroughly.
20. **USE ONLY GENUINE REPLACEMENT PARTS.** Replacement parts not original may void your warranty and can lead to malfunction and resulting injuries. Genuine parts are available from your dealer.
21. **DO NOT MODIFY THE COMPRESSOR.** Do not modify the compressor. Always contact the authorized service centre any repairs. Unauthorised modification may not only impair the compressor performance but may also result in accident or injury to repair personnel who do not have the required knowledge and technical expertise to perform the repair operations correctly. Unauthorised modifications may increase the risk of injury to the user or the risk of property damage.
22. **TURN OFF THE SWITCH WHEN THE COMPRESSOR IS NOT USED.** When the compressor is not used, turn the switch OFF, disconnect it from the power source and open the drain cock to discharge the compressed air from the air tank.
23. **NEVER TOUCH HOT SURFACE.** To reduce the risk of burns, do not touch tubes, heads, cylinder and motors.
24. **DO NOT DIRECT AIR STREAM AT BODY.** Risk of injury, do not direct air stream at persons or animals.
25. **DRAIN TANK DAILY OR AFTER EACH USE.** Open the drain valve and tilt compressor to completely empty accumulated water. Failure to properly drain tank may result in excessive corrosion, which may cause sudden air tank rupture or explosion.
26. **DO NOT STOP COMPRESSOR BY PULLING OUT THE BATTERY.** Use the auto ON/ OFF switch.
27. **USE ONLY RECOMMENDED AIR HANDLING PARTS ACCEPTABLE FOR PRESSURE NOT LESS THAN 9.3 BAR** Risk of bursting. Use only recommended air handling parts acceptable for pressures not less than 9.3 bar.
28. **WEAR PROPER HEARING AND HEAD PROTECTION.** Suitable protective clothing must be worn when operating the compressor and connected tool or accessory. Consult the tool/ accessory manual and adhere to any safety requirements.
29. **MAKE ALLOWANCE FOR ENVIRONMENTAL CONDITIONS.** Never leave the compressor in the rain. Never use the compressor in damp or wet conditions. Provide good lighting. Never use the compressor near combustible liquids or gases.
30. **DO NOT OPERATE IN EXPLOSIVE ATMOSPHERES, SUCH AS IN THE PRESENCE OF FLAMMABLE LIQUIDS, GASES OR DUST.** Compressors can create sparks which may ignite the dust or fumes.

31. **CHECK THE PRESSURE VESSEL FOR SIGNS OF RUST AND DAMAGE EACH TIME BEFORE USING.** Do not use the compressor with a damaged or rusty pressure vessel.

## Residual Risks

In spite of the application of the relevant safety regulations and the implementation of safety devices, certain residual risks cannot be avoided. These are:

- Impairment of hearing.
- Risk of personal injury due to flying particles.
- Risk of burns due to accessories becoming hot during operation.
- Risk of personal injury due to prolonged use.
- Risk of personal injury if the adjusted pressure is higher than maximum pressure of the tool.

## Electrical Safety

The electric motor has been designed for one voltage only. Always check that the battery pack voltage corresponds to the voltage on the rating plate. Also make sure that the voltage of your charger corresponds to that of your mains.



Your DeWALT charger is double insulated in accordance with EN60335; therefore no earth wire is required.

If the supply cord is damaged, it must be replaced by a specially prepared cord available through the DeWALT service organisation.

## Mains Plug Replacement (U.K. & Ireland Only)

If a new mains plug needs to be fitted:

- Safely dispose of the old plug.
- Connect the brown lead to the live terminal in the plug.
- Connect the blue lead to the neutral terminal.



**WARNING:** No connection is to be made to the earth terminal.

Follow the fitting instructions supplied with good quality plugs. Recommended fuse: 3 A.

## Using an Extension Cable

An extension cord should not be used unless absolutely necessary. Use an approved extension cable suitable for the power input of your charger (see **Technical Data**). The minimum conductor size is 1 mm<sup>2</sup>; the maximum length is 30 m.

When using a cable reel, always unwind the cable completely.

## SAVE THESE INSTRUCTIONS

## Chargers

DeWALT chargers require no adjustment and are designed to be as easy as possible to operate.

## Important Safety Instructions for All Battery Chargers

**SAVE THESE INSTRUCTIONS:** This manual contains important safety and operating instructions for compatible battery chargers (refer to **Technical Data**).

- Before using charger, read all instructions and cautionary markings on charger, battery pack, and product using battery pack.



**WARNING:** Shock hazard. Do not allow any liquid to get inside charger. Electric shock may result.



**WARNING:** We recommend the use of a residual current device with a residual current rating of 30mA or less.



**CAUTION:** Burn hazard. To reduce the risk of injury, charge only DEWALT rechargeable batteries. Other types of batteries may burst causing personal injury and damage.



**CAUTION:** Children should be supervised to ensure that they do not play with the appliance.

**NOTICE:** Under certain conditions, with the charger plugged into the power supply, the exposed charging contacts inside the charger can be shorted by foreign material. Foreign materials of a conductive nature such as, but not limited to, steel wool, aluminum foil or any buildup of metallic particles should be kept away from charger cavities. Always unplug the charger from the power supply when there is no battery pack in the cavity. Unplug charger before attempting to clean

- **DO NOT attempt to charge the battery pack with any chargers other than the ones in this manual.** The charger and battery pack are specifically designed to work together.
- **These chargers are not intended for any uses other than charging DEWALT rechargeable batteries.** Any other uses may result in risk of fire, electric shock or electrocution.
- **Do not expose charger to rain or snow.**
- **Pull by plug rather than cord when disconnecting charger.** This will reduce risk of damage to electric plug and cord.
- **Make sure that cord is located so that it will not be stepped on, tripped over, or otherwise subjected to damage or stress.**
- **Do not use an extension cord unless it is absolutely necessary.** Use of improper extension cord could result in risk of fire, electric shock, or electrocution.
- **Do not place any object on top of charger or place the charger on a soft surface that might block the ventilation slots and result in excessive internal heat.** Place the charger in a position away from any heat source. The charger is ventilated through slots in the top and the bottom of the housing.
- **Do not operate charger with damaged cord or plug—** have them replaced immediately.
- **Do not operate charger if it has received a sharp blow, been dropped, or otherwise damaged in any way.** Take it to an authorised service centre.
- **Do not disassemble charger; take it to an authorised service centre when service or repair is required.** Incorrect

reassembly may result in a risk of electric shock, electrocution or fire.

- In case of damaged power supply cord the supply cord must be replaced immediately by the manufacturer, its service agent or similar qualified person to prevent any hazard.
- **Disconnect the charger from the outlet before attempting any cleaning. This will reduce the risk of electric shock.** Removing the battery pack will not reduce this risk.
- **NEVER** attempt to connect two chargers together.
- **The charger is designed to operate on standard 230V household electrical power. Do not attempt to use it on any other voltage.** This does not apply to the vehicular charger.







### Charging a Battery (Fig. B)

1. Plug the charger into an appropriate outlet before inserting battery pack.
2. Insert the battery pack ② into the charger, making sure the battery pack is fully seated in the charger. The red (charging) light will blink repeatedly indicating that the charging process has started.
3. The completion of charge will be indicated by the red light remaining ON continuously. The battery pack is fully charged and may be used at this time or left in the charger. To remove the battery pack from the charger, push the battery release button ③ on the battery pack.

**NOTE:** To ensure maximum performance and life of lithium-ion battery packs, charge the battery pack fully before first use.

### Charger Operation

Refer to the indicators below for the charge status of the battery pack.

Charge Indicators		
	Charging	
	Fully Charged	
	Hot/Cold Pack Delay*	

\*The red light will continue to blink, but a yellow indicator light will be illuminated during this operation. Once the battery pack has reached an appropriate temperature, the yellow light will turn off and the charger will resume the charging procedure.

The compatible charger(s) will not charge a faulty battery pack. The charger will indicate faulty battery by refusing to light or by displaying problem pack or charger blink pattern.

**NOTE:** This could also mean a problem with a charger.

If the charger indicates a problem, take the charger and battery pack to be tested at an authorised service centre.

### Hot/Cold Pack Delay

When the charger detects a battery pack that is too hot or too cold, it automatically starts a Hot/Cold Pack Delay, suspending charging until the battery pack has reached an appropriate temperature. The charger then automatically switches to the



pack charging mode. This feature ensures maximum battery pack life.

A cold battery pack will charge at a slower rate than a warm battery pack. The battery pack will charge at that slower rate throughout the entire charging cycle and will not return to maximum charge rate even if the battery pack warms.

The DCB118 charger is equipped with an internal fan designed to cool the battery pack. The fan will turn on automatically when the battery pack needs to be cooled. Never operate the charger if the fan does not operate properly or if ventilation slots are blocked. Do not permit foreign objects to enter the interior of the charger.

### Electronic Protection System

XR Li-Ion tools are designed with an Electronic Protection System that will protect the battery pack against overloading, overheating or deep discharge.

The tool will automatically turn off if the Electronic Protection System engages. If this occurs, place the lithium-ion battery pack on the charger until it is fully charged.

### Wall Mounting

These chargers are designed to be wall mountable or to sit upright on a table or work surface. If wall mounting, locate the charger within reach of an electrical outlet, and away from a corner or other obstructions which may impede air flow. Use the back of the charger as a template for the location of the mounting screws on the wall. Mount the charger securely using drywall screws (purchased separately) at least 25.4 mm long with a screw head diameter of 7–9 mm, screwed into wood to an optimal depth leaving approximately 5.5 mm of the screw exposed. Align the slots on the back of the charger with the exposed screws and fully engage them in the slots.

### Charger Cleaning Instructions



**WARNING: Shock hazard. Disconnect the charger from the AC outlet before cleaning.** Dirt and grease may be removed from the exterior of the charger using a cloth or soft non-metallic brush. Do not use water or any cleaning solutions. Never let any liquid get inside the tool; never immerse any part of the tool into a liquid.

## Battery Packs

### Important Safety Instructions for All Battery Packs

When ordering replacement battery packs, be sure to include catalogue number and voltage.

The battery pack is not fully charged out of the carton. Before using the battery pack and charger, read the safety instructions below. Then follow charging procedures outlined.

#### READ ALL INSTRUCTIONS

- **Do not charge or use battery in explosive atmospheres, such as in the presence of flammable liquids, gases or dust.** Inserting or removing the battery from the charger may ignite the dust or fumes.
- **Never force battery pack into charger. Do not modify battery pack in any way to fit into a non-compatible**

**charger as battery pack may rupture causing serious personal injury.**

- Charge the battery packs only in DEWALT chargers.
- **DO NOT splash or immerse in water or other liquids.**
- **Do not store or use the tool and battery pack in locations where the temperature may reach or exceed 40 °C (104 °F) (such as outside sheds or metal buildings in summer).**
- **Do not incinerate the battery pack even if it is severely damaged or is completely worn out.** The battery pack can explode in a fire. Toxic fumes and materials are created when lithium-ion battery packs are burned.
- **If battery contents come into contact with the skin, immediately wash area with mild soap and water.** If battery liquid gets into the eye, rinse water over the open eye for 15 minutes or until irritation ceases. If medical attention is needed, the battery electrolyte is composed of a mixture of liquid organic carbonates and lithium salts.
- **Contents of opened battery cells may cause respiratory irritation.** Provide fresh air. If symptoms persists, seek medical attention.



**WARNING: Burn hazard.** Battery liquid may be flammable if exposed to spark or flame.



**WARNING: Never attempt to open the battery pack for any reason.** If battery pack case is cracked or damaged, do not insert into charger. Do not crush, drop or damage battery pack. Do not use a battery pack or charger that has received a sharp blow, been dropped, run over or damaged in any way (i.e., pierced with a nail, hit with a hammer, stepped on). Electric shock or electrocution may result. Damaged battery packs should be returned to service centre for recycling.



**WARNING: Fire hazard. Do not store or carry the battery pack so that metal objects can contact exposed battery terminals.** For example, do not place the battery pack in aprons, pockets, tool boxes, product kit boxes, drawers, etc., with loose nails, screws, keys, etc.



**CAUTION: When not in use, place tool on its side on a stable surface where it will not cause a tripping or falling hazard.** Some tools with large battery packs will stand upright on the battery pack but may be easily knocked over.

### Transportation



**WARNING: Fire hazard.** Transporting batteries can possibly cause fire if the battery terminals inadvertently come in contact with conductive materials. When transporting batteries, make sure that the battery terminals are protected and well insulated from materials that could contact them and cause a short circuit.

DEWALT batteries comply with all applicable shipping regulations as prescribed by industry and legal standards which include UN Recommendations on the Transport of Dangerous Goods; International Air Transport Association (IATA) Dangerous Goods Regulations, International Maritime Dangerous Goods (IMDG) Regulations, and the European Agreement Concerning



The International Carriage of Dangerous Goods by Road (ADR). Lithium-ion cells and batteries have been tested to section 38.3 of the UN Recommendations on the Transport of Dangerous Goods Manual of Tests and Criteria.

In most instances, shipping a DEWALT battery pack will be excepted from being classified as a fully regulated Class 9 Hazardous Material. In general, only shipments containing a lithium-ion battery with an energy rating greater than 100 Watt Hours (Wh) will require being shipped as fully regulated Class 9. All lithium-ion batteries have the Watt Hour rating marked on the pack. Furthermore, due to regulation complexities, DEWALT does not recommend air shipping lithium-ion battery packs alone regardless of Watt Hour rating. Shipments of tools with batteries (combo kits) can be air shipped as excepted if the Watt Hour rating of the battery pack is no greater than 100 Whr. Regardless of whether a shipment is considered excepted or fully regulated, it is the shipper's responsibility to consult the latest regulations for packaging, labeling/markings and documentation requirements.

The information provided in this section of the manual is provided in good faith and believed to be accurate at the time the document was created. However, no warranty, expressed or implied, is given. It is the buyer's responsibility to ensure that its activities comply with the applicable regulations.

**Transporting the FLEXVOLT™ Battery**

The DEWALT FLEXVOLT™ battery has two modes: **Use** and **Transport**.

**Use Mode:** When the FLEXVOLT™ battery stands alone or is in a DEWALT 18V product, it will operate as an 18V battery. When the FLEXVOLT™ battery is in a 54V or a 108V (two 54V batteries) product, it will operate as a 54V battery.

**Transport Mode:** When the cap is attached to the FLEXVOLT™ battery, the battery is in Transport mode. Keep the cap for shipping.

When in Transport mode, strings of cells are electrically disconnected within the pack resulting in 3 batteries with a lower Watt hour (Wh) rating as compared to 1 battery with a higher Watt hour rating. This increased quantity of 3 batteries with the lower Watt hour rating can exempt the pack from certain shipping regulations that are imposed upon the higher Watt hour batteries.

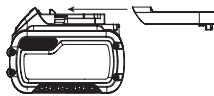

For example, the Transport Wh rating might indicate 3 x 36 Wh, meaning 3 batteries of 36 Wh each. The Use Wh rating might indicate 108 Wh (1 battery implied).

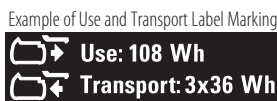

**Storage Recommendations**

1. The best storage place is one that is cool and dry away from direct sunlight and excess heat or cold. For optimum battery performance and life, store battery packs at room temperature when not in use.

2. For long storage, it is recommended to store a fully charged battery pack in a cool, dry place out of the charger for optimal results.

**NOTE:** Battery packs should not be stored completely depleted of charge. The battery pack will need to be recharged before use.

**Labels on Charger and Battery Pack**

In addition to the pictographs used in this manual, the labels on the charger and the battery pack may show the following pictographs:



Read instruction manual before use.



See **Technical Data** for charging time.



Do not probe with conductive objects.



Do not charge damaged battery packs.



Do not expose to water.



Have defective cords replaced immediately.



Charge only between 4 °C and 40 °C.



Only for indoor use.



Discard the battery pack with due care for the environment.



Charge DEWALT battery packs only with designated DEWALT chargers. Charging battery packs other than the designated DEWALT batteries with a DEWALT charger may make them burst or lead to other dangerous situations.



Do not incinerate the battery pack.



USE (without transport cap). Example: Wh rating indicates 108 Wh (1 battery with 108 Wh).



TRANSPORT (with built-in transport cap). Example: Wh rating indicates 3 x 36 Wh (3 batteries of 36 Wh).

**Battery Type**

The DCC1054 operates on a 54 volt battery pack.

These battery packs may be used: DCB546, DCB547. Refer to **Technical Data** for more information.

## Package Contents

The package contains:

- 1 Air compressor
- 2 Li-Ion battery packs (T2 models only)
- 1 Charger (T2 models only)
- 1 Instruction manual

**NOTE:** Battery packs, chargers and kitboxes are not included with N-models.

- Check for damage to the tool, parts or accessories which may have occurred during transport.
- Take the time to thoroughly read and understand this manual prior to operation.

## Markings on Tool

The following pictograms are shown on the tool:



Read instruction manual before use.



Wear ear and eye protection.



Air tank capacity.



Approx. cut-out pressure.



Air displacement.



Oil-less pump.



Set outlet pressure to zero before the air hose is attached or removed.



Risk of high temperatures.

**CAUTION:** the compressor contains some parts which might reach high temperatures.



Risk of accidental start-up.

**NOTICE:** The compressor could start automatically in case of a black-out and subsequent reset.

**WARNING:** Compressor unit may start without warning.



Outdoor noise level

## Important Information

Read and understand all of the operating instructions, safety precautions and warnings in the Instruction Manual before operating or maintaining this compressor. Most accidents that result from compressor operation and maintenance are caused by the failure to observe basic safety rules or precautions. An accident can often be avoided by recognizing a potentially hazardous situation before it occurs, and by observing appropriate safety

procedures. Basic safety precautions are outlined in the "SAFETY" section of this Instruction Manual and in the sections which contain the operation and maintenance instructions. Hazards that must be avoided to prevent bodily injury or machine damage are identified by WARNINGS on the compressor and in this Instruction Manual.

## Date Code Position (Fig. A)

The date code **13**, which also includes the year of manufacture, is printed on a label on the rear of the tank.

Example:

2017 XX XX  
Year of Manufacture

## Description (Fig. A)



**WARNING:** Never modify the power tool or any part of it. Damage or personal injury could result.

- 1 Auto On/Off switch
- 2 Battery
- 3 Battery release button
- 4 Safety valve
- 5 Tank pressure gauge
- 6 One-Turn regulator
- 7 Drain valve
- 8 Check valve
- 9 Quick-connect coupler
- 10 Carry handle
- 11 Tank

## Intended Use

Your compressor is designed for professional finish nailing and stapling applications.

**DO NOT** use under wet conditions or in the presence of flammable liquids or gases. **DO NOT** use or store the compressor at temperatures below 0 °C.

Your compressor is a professional power tool.

**DO NOT** let children come into contact with the tool.

Supervision is required when inexperienced operators use this tool.

- **Young children and the infirm.** This appliance is not intended for use by young children or infirm persons without supervision.
- This product is not intended for use by persons (including children) suffering from diminished physical, sensory or mental abilities; lack of experience, knowledge or skills unless they are supervised by a person responsible for their safety. Children should never be left alone with this product.

## ASSEMBLY AND ADJUSTMENTS



**WARNING:** To reduce the risk of serious personal injury, turn tool off and disconnect battery pack before making any adjustments or removing/installing attachments or accessories. An accidental start-up can cause injury.



**WARNING:** Use only DEWALT battery packs and chargers.

## Inserting and Removing the Battery Pack from the Tool (Fig. C, D)

**NOTE:** Make sure your battery pack 2 is fully charged.

### To Install the Battery Pack into the Tool Handle

1. Align the battery pack 2 with the rails inside the tool's handle (Fig. C).
2. Slide it into the handle until the battery pack is firmly seated in the tool and ensure that you hear the lock snap into place.

### To Remove the Battery Pack from the Tool

1. Press the release button 3 and firmly pull the battery pack out of the tool handle.
2. Insert battery pack into the charger as described in the charger section of this manual.

### Fuel Gauge Battery Packs (Fig. D)

Some DeWALT battery packs include a fuel gauge which consists of three green LED lights that indicate the level of charge remaining in the battery pack.

To actuate the fuel gauge, press and hold the fuel gauge button 12. A combination of the three green LED lights will illuminate designating the level of charge left. When the level of charge in the battery is below the usable limit, the fuel gauge will not illuminate and the battery will need to be recharged.

**NOTE:** The fuel gauge is only an indication of the charge left on the battery pack. It does not indicate tool functionality and is subject to variation based on product components, temperature and end-user application.

## OPERATION

### Instructions for Use



**WARNING:** Always observe the safety instructions and applicable regulations.



**WARNING:** To reduce the risk of serious personal injury, turn tool off and disconnect battery pack before making any adjustments or removing/installing attachments or accessories. An accidental start-up can cause injury.



**WARNING:** Ensure the compressor is placed firmly to a stable flat surface. Failure to do so could cause the compressor to be unstable and fall causing personal injury.

### Know Your Air Compressor

READ THIS OWNER'S MANUAL AND SAFETY RULES BEFORE OPERATING YOUR UNIT. Compare the illustrations with your unit to familiarise yourself with the location of various controls and adjustments. Save this manual for future reference.

### Description of Operation (Fig. A)

Become familiar with these controls before operating the unit.

**Auto On(I)/Off(O) Switch 1:** Place this switch in the "Auto On" position to provide automatic power to the pressure switch and "Off" to remove power at the end of each use.

**Pressure Switch (not shown):** The pressure switch automatically starts the motor when the air tank pressure drops below the factory set "cut-in" pressure. It stops the motor when the air tank pressure reaches the factory set "cut-out" pressure.

**Safety Valve 4:** If the pressure switch does not shut off the air compressor at its "cut-out" pressure setting, the safety valve will protect against high pressure by "popping out" at its factory set pressure (slightly higher than the pressure switch "cut-out" setting).

**Tank Pressure Gauge 5:** The tank pressure gauge indicates the reserve air pressure in the tank.

**One-Turn Regulator 6:** Controls the air pressure available at the quick-connect outlet. Turn the One-Turn regulator clockwise to increase pressure or anti-clockwise to decrease pressure. Stop when indicator matches with desired outlet pressure.

**Cooling System (not shown):** This compressor contains an advanced design cooling system. At the heart of this cooling system is an engineered fan. It is perfectly normal for this fan to blow air through the vent holes in large amounts. You know that the cooling system is working when air is being expelled.

**Air Compressor Pump (not shown):** Compresses air into the air tank. Working air is not available until the compressor has raised the air tank pressure above that required at the air outlet.

**Drain Valve 7:** The drain valve is located at the base of the air tank and is used to drain condensation at the end of each use.

**Check Valve 8:** When the air compressor is operating, the check valve is "open", allowing compressed air to enter the air tank. When the air compressor reaches "cut-out" pressure, the check valve "closes", allowing air pressure to remain inside the air tank.

**Motor Overload Protector (not shown):** The motor has a thermal overload protector. If the motor overheats for any reason, the overload protector will shut off the motor. The motor must be allowed to cool down before restarting. To restart:

1. Set the Auto On/Off switch to "Off".
2. Remove the battery.
3. Allow the motor to cool.
4. Replace the battery.
5. Set the Auto On/Off switch to "Auto On" position.

**Quick-Connect Coupler 9:** The Universal EU 1/4" quick coupling body accepts industrial Push-to-Connect plugs.

### How to Use Your Unit (Fig. E)

#### How to Stop



**WARNING:** When loosening the hose coupling from the quick-connect coupler 9, the coupling piece of the hose must be held by hand in order to avoid injuries caused by the recoiling hose.

1. Set the Auto On/Off switch 1 to "Off".
2. Turn the One-Turn regulator 6 anti-clockwise to set the outlet pressure to zero.
3. Remove hose and tool/accessories.
4. Remove battery when not in use.

### Before Starting

 **WARNING:** Do not operate this unit until you read this instruction manual for safety, operation and maintenance instructions.

### Before Each Start-Up

1. Set the Auto On/Off switch ① to "Off".
2. Remove battery. (Refer to **Installing and Removing the Battery Pack from the Tool**)
3. Turn the One-Turn regulator ⑥ counterclockwise to set the outlet pressure to zero.
4. Attach hose and tool/accessories.

 **WARNING: Risk of unsafe operation. Firmly grasp air hose in hand when installing or disconnecting to prevent hose whip.**

 **WARNING: Risk of unsafe operation. Do not use damaged or worn accessories.**

**NOTE:** The hose or accessory will require a quick connect plug if the air outlet is equipped with a quick connect body ⑨.

 **WARNING: Risk of Bursting.** Too much air pressure causes a hazardous risk of bursting. Check the manufacturer's maximum pressure rating for air tools and accessories. The regulator outlet pressure must never exceed the maximum pressure rating.

**NOTICE: Risk of property damage.** Compressed air from the unit may contain water condensation and oil mist. Do not spray unfiltered air at an item that could be damaged by moisture. Some air tools and accessories may require filtered air. Read the instructions for the air tools and accessories.

### How to Start

1. Install the battery into the compressor.
2. Attach hose and tool/accessories.
3. Set the Auto On/Off switch ① to "Auto On" and allow tank pressure to build. Motor will stop when tank pressure reaches "cut-out" pressure.
4. Turn One-Turn regulator ⑥ clockwise to increase pressure and stop when desired pressure is reached.

**NOTE:** Make sure that the desired pressure is not more than the maximum pressure of the connected hose or the connected tool.

 **WARNING: Risk of unsafe operation. If any unusual noise or vibration is noticed, stop the compressor immediately and have it checked by a trained service technician.**

 **WARNING:** Ensure the regulator is set to a pressure lower than the maximum operating pressure of the tool.

The compressor is ready for use.

### MAINTENANCE

Your DeWALT power tool has been designed to operate over a long period of time with a minimum of maintenance. Continuous satisfactory operation depends upon proper tool care and regular cleaning.

 **WARNING:** To reduce the risk of serious personal injury, turn tool off and disconnect battery pack before making any adjustments or removing/installing attachments or accessories. An accidental start-up can cause injury.

The charger and battery pack are not serviceable.

### Customer Responsibilities

	Before each use	Daily or after each use
Check Safety Valve	X	
Drain Tank		X
Check for air leaks		X
Check for unusual noise/vibration		X
Check hose and tool connection	X	
Adjustment of pressure control	X	

 **WARNING: Risk of unsafe operation.** Unit cycles automatically when power is on. When performing maintenance, you may be exposed to voltage sources, compressed air, or moving parts. Personal injuries can occur. Before performing any maintenance or repair, disconnect power source from the compressor and bleed off all air pressure.

**NOTE:** Refer to the **Operation** section for the location of controls.

#### To Check Safety Valve (Fig. E)

 **WARNING: Risk of Bursting.** If the safety valve does not work properly, over-pressurization may occur, causing air tank rupture or an explosion.



 **WARNING: Risk from Flying Objects.** Always wear certified eye protection with side shields.

Before starting compressor, pull the ring on the safety valve ④ to make sure that the safety valve operates freely. If the valve is stuck or does not operate smoothly. Contact the DeWALT service centre.

 **WARNING:** Do not pull the ring of the safety valve if the tank is under pressure!

#### To Drain Tank (Fig. E, F)

 **WARNING: Risk of Unsafe Operation.** Air tanks contain high pressure air. Keep face and other body parts away from outlet of drain. Use eye protection when draining as debris can be kicked up into face.



 **WARNING: Risk from noise.** Always wear proper hearing protection during use. Under some conditions and duration of use, noise from this product may contribute to hearing loss.

**NOTE:** All compressed air systems generate condensate that accumulates in any drain point (e.g., tanks, filter, aftercoolers, dryers). This condensate contains lubricating oil and/or substances which may be regulated and must be disposed of in accordance with current regulations.

**WARNING: Risk of Bursting.** Water will condense in the air tank. If not drained, water will corrode and weaken the air tank causing a risk of air tank rupture.

**NOTICE: Risk of Property Damage.** Drain water from air tank may contain oil and rust which can cause stains.

1. Set the Auto On/Off switch 1 to "Off".
2. Remove the battery.
3. Turn the One-Turn regulator 6 counterclockwise to set the outlet pressure to zero.
4. Remove the air tool or accessory.

**WARNING:** When loosening the hose coupling from the quick-connect coupler 9, the coupling piece of the hose must be held by hand in order to avoid injuries caused by the recoiling hose.

5. Place a suitable container under the drain valve to catch discharge.
6. Pull ring on safety valve 4 allowing air to bleed from the tank until tank pressure is approximately 1.4 BAR. Release safety valve ring.
7. Drain water from air tank by opening drain valve 7 on bottom of tank.
8. After the water has been drained, close the drain valve. The air compressor can now be stored.

**NOTE:** If drain valve is blocked, release all air pressure by connecting a tool to the airline and operating it until tank pressure is zero BAR and contact the DeWALT service centre.

## Storage

Before you store the air compressor, make sure you do the following:

1. Review the **Maintenance** section and perform scheduled maintenance as necessary.
2. Always toggle Auto On/Off Switch to "Off" and remove battery. Drain water from air tank. Refer to **To Drain Tank** under **Maintenance**.

**WARNING: Water will condense in the air tank. If not drained, water will corrode and weaken the air tank causing a risk of air tank rupture.**

3. Store the air compressor in a clean and dry location.
4. Make sure the air compressor is secured in such a way that it cannot be started up again by any unauthorized person.
5. Frost destroys the pump and accessories as both always contain water. If there is a risk of danger of frost, store in frost-free conditions.



## Cleaning

**WARNING:** Blow dirt and dust out of the main housing with dry air as often as dirt is seen collecting in and around the air vents. Wear approved eye protection and approved dust mask when performing this procedure.

**WARNING:** Never use solvents or other harsh chemicals for cleaning the non-metallic parts of the tool. These chemicals may weaken the materials used in these parts.

Use a cloth dampened only with water and mild soap. Never let any liquid get inside the tool; never immerse any part of the tool into a liquid.

## Optional Accessories

**WARNING:** Since accessories, other than those offered by DeWALT, have not been tested with this product, use of such accessories with this tool could be hazardous. To reduce the risk of injury, only DeWALT recommended accessories should be used with this product.

Consult your dealer for further information on the appropriate accessories.

## Protecting the Environment



Separate collection. Products and batteries marked with this symbol must not be disposed of with normal household waste.

Products and batteries contain materials that can be recovered or recycled reducing the demand for raw materials. Please recycle electrical products and batteries according to local provisions. Further information is available at [www.2helpU.com](http://www.2helpU.com).

## Rechargeable Battery Pack

This long life battery pack must be recharged when it fails to produce sufficient power on jobs which were easily done before. At the end of its technical life, discard it with due care for our environment:

- Run the battery pack down completely, then remove it from the tool.
- Li-Ion cells are recyclable. Take them to your dealer or a local recycling station. The collected battery packs will be recycled or disposed of properly.

## GLOSSARY

**Cut-In Pressure:** While the motor is off, air tank pressure drops when accessory is used. When the tank pressure drops to a certain low level the motor will restart automatically. The low pressure at which the motor automatically restarts is called **cut-in** pressure.

**Cut-Out Pressure:** When an air compressor is turned on and begins to run, air pressure in the air tank begins to build. It builds to a certain high pressure before the motor automatically shuts off, protecting your air tank from pressure higher than its capacity. The high pressure at which the motor shuts off is called **cut-out** pressure.

**Duty Cycle:** This air compressor pump is capable of running continuously. However, to prolong the life of your air compressor, it is recommended that a 50%–75% average duty cycle be maintained; that is, the air compressor pump should not run more than 30–45 minutes in any given hour.

## Troubleshooting Guide

This section provides a list of the more frequently encountered malfunctions, their causes and corrective actions. The operator or maintenance personnel can perform some corrective actions, and others may require the assistance of a qualified DEWALT technician or your dealer.

Code	Possible Cause	Possible Solution
1	Pressure switch does not shut off motor when compressor reaches cut-out pressure	Set the Auto On/Off switch to "Off" and remove the battery, if the unit does not shut off contact a DEWALT service organisation.
2	Pressure switch cut-out too high	Contact a DEWALT service organisation.
3	Tube fittings are not tight enough	Tighten fittings where air can be heard escaping. Check fittings with soapy water solution. <b>Do Not Overtighten.</b>
4	Defective air tank	Air tank must be replaced. Do not repair the leak. Contact a DEWALT service organisation.  <b>WARNING: Risk of bursting.</b> Do not drill into, weld or otherwise modify air tank or it will weaken. The air tank can rupture or explode.
5	Leaking seals	Contact a DEWALT service organisation.
6	Defective safety valve	Operate safety valve manually by pulling on ring. If valve still leaks, it must be replaced. Contact a DEWALT service organisation.
7	Regulator is not adjusted correctly for accessory being used	It is normal for some pressure drop to occur when an accessory is used, adjust the One-Turn regulator as instructed in <b>One-Turn Regulator</b> under <b>Description of Operations</b> if pressure drop is excessive. <b>NOTE:</b> Adjust the regulated pressure under flow conditions while accessory is being used.
8	Prolonged excessive use of air	Decrease amount of air usage.
9	Compressor doesn't provide enough air for accessory	Check the accessory air requirement. If it is higher than the Air Delivery (l/min) or pressure supplied by your air compressor, a more powerful compressor is needed to operate accessory.
11	Check valve restricted	Contact a DEWALT service organisation.
12	Air leaks	Tighten fittings.
13	Regulator is damaged	Contact a DEWALT service organisation.
14	Motor overload protection switch has tripped	Refer to <b>Motor Overload Protector</b> under <b>Description of Operations</b> . If motor overload protection trips frequently, contact a DEWALT service organisation.
15	Tank pressure exceeds pressure switch cut-in pressure	Motor will start automatically when tank pressure drops below cut-in pressure of pressure switch.
16	Loose electrical connections	Contact a DEWALT service organisation.
17	Possible defective motor	Contact a DEWALT service organisation.
18	Paint spray on internal motor parts	Contact a DEWALT service organisation. Do not operate the compressor in the paint spray area. Refer to flammable vapor warning.
19	Pump does not run because tank pressure is above cut-in pressure.	Drain tank to below cut-in pressure when pump turns on.
20	Pump does not run due to safety fault.	Cycle Auto On/Off Switch from "Off" to "Auto On."

## Troubleshooting Codes

Problem	Code
Excessive air tank pressure-safety valve pops off	1, 2
Air leaks	3
Air leaks in air tank or at air tank welds	4
Air leaks between head and valve plate	5
Air leaks from safety valve	6
Compressor is not supplying enough air to operate accessories	7, 8, 9, 10, 11, 12
Regulator knob has continuous air leak	13
Regulator will not shut off air outlet	13
Motor will not run	6, 14, 15, 16, 17, 18, 19, 20





<b>Belgique et Luxembourg België en Luxemburg</b>	DeWALT - Belgium BVBA Egide Walschaertsstraat 16 2800 Mechelen	Tel: NL 32 15 47 37 63 Tel: FR 32 15 47 37 64 Fax: 32 15 47 37 99	www.dewalt.be enduser.BE@SBDinc.com
<b>Danmark</b>	DeWALT (Stanley Black&Decker AS) Roskildevej 22 2620 Albertslund	Tel: 70 20 15 10 Fax: 70 22 49 10	www.dewalt.dk kundeservice.dk@sbdinc.com
<b>Deutschland</b>	DeWALT Richard Klingler Str. 11 65510 Idstein	Tel: 06126-21-0 Fax: 06126-21-2770	www.dewalt.de infofwg@sbidnc.com
<b>Ελλάς</b>	DeWALT (Ελλάς) A.E. ΕΔΠΑ-ΓΡΑΦΕΙΑ : Στραβόμονος 7 & Α. Βουλιαγμένης, Πλωράδα 166 74, Αθήνα SERVICE : Ημέρος, Τόπος (2 Χάν Αβάρ) – 193 00 Ασπρόπυργος	Τηλ: 00302108981616 Φαξ: 00302108983570	www.dewalt.gr Greece.Service@sbidnc.com
<b>España</b>	DeWALT Ibérica, S.C.A. Parc de Negocios "Mas Blau" Edificio Muntadas, c/Bergadà, 1, Of. A6 08820 El Prat de Llobregat (Barcelona)	Tel: 934 797 400 Fax: 934 797 419	www.dewalt.es respuesta.postventa@sbidnc.com
<b>France</b>	DeWALT 5, allée des Hêtres BP 60105, 69579 Limonest Cedex	Tel: 04 72 20 39 20 Fax: 04 72 20 39 00	www.dewalt.fr scufi@sbidnc.com
<b>Schweiz Suisse Svizzera</b>	DeWALT In der Luberzen 42 8902 Urdorf	Tel: 044 - 755 60 70 Fax: 044 - 730 70 67	www.dewalt.ch service@rofaag.ch
<b>Ireland</b>	DeWALT Building 4500, Kinsale Road Cork Airport Business Park Cork, Ireland	Tel: 00353-2781800 Fax: 01278 1811	www.dewalt.ie Sales.ireland@sbidnc.com
<b>Italia</b>	DeWALT via EnergyPark 6 20871 Vimercate (MB), IT	Tel: 800-014353 39 039-9590200 Fax: 39 039-9590311	www.dewalt.it
<b>Nederlands</b>	DeWALT Netherlands BVPostbus 83, 6120 AB BORN	Tel: 31 164 283 063 Fax: 31 164 283 200	www.dewalt.nl
<b>Norge</b>	DeWALT Postboks 4613 0405 Oslo, Norge	Tel: 45 25 13 00 Fax: 45 25 08 00	www.dewalt.no kundeservice.no@sbidnc.com
<b>Österreich</b>	DeWALT Werkzeug Vertriebsges m.b.H Oberlaaerstrasse 248, A-1230 Wien	Tel: 01 - 66116 - 0 Fax: 01 - 66116 - 614	www.dewalt.at service.austria@sbidnc.com
<b>Portugal</b>	DeWALT Ed. D Dinis, Quina da Fonte Rua dos Malhoes 2 2A 2º Esq. Oeiras e S. Juliao da Barra, paço de Arcos e Caxias 2770 071 Paço de Arcos	Tel: +351 214667500 Fax: +351214667580	www.dewalt.pt resposta.postventa@sbidnc.com
<b>Suomi</b>	DeWALT PL47 00521 Helsinki, Suomi	Puh: 010 400 4333 Faksi: 0800 411 340	www.dewalt.fi asiakaspalvelu.fi@sbidnc.com
<b>Sverige</b>	DeWALT BOX 94 43122 Mölndal Sverige	Tel: 031 68 61 60 Fax: 031 68 60 08	www.dewalt.se kundservice.se@sbidnc.com
<b>Türkiye</b>	Sanayi ve Ticaret Bakanlığı tebliğince kullanılmı 7 yıldır. Stanley Black & Decker Turkey Alet Üretim San. Tic. Ltd.Şti. Kozyatağı Mh Değirmen Sk. Nida Kule No: 18 Kat: 6, 34742 Kadıköy, İstanbul, Türkiye	Tel: +90 216 665 2900 Faks: +90 216 665 2901	www.dewalt.com.tr info-tr@sbidnc.com
<b>United Kingdom</b>	DeWALT 210 Bath Road; Slough, Berks SL1 3YD	Tel: 01753-567055 Fax: 01753-572112	www.dewalt.co.uk emeaservice@sbidnc.com
<b>Australia</b>	DeWALT 810 Whitehorse Road Box Hill VIC 3103 Australia	Tel: Aust 1800 338 002 Tel: NZ 0800 339 258	www.dewalt.com.au www.dewalt.co.nz
<b>Middle East Africa</b>	DeWALT P.O. Box - 17164, Jebel Ali Free Zone (South), Dubai, UAE	Tel: 971 4 812 7400 Fax: 971 4 2822765	www.dewalt.ae Service.MEA@sbidnc.com