

# BLACK+ DECKER

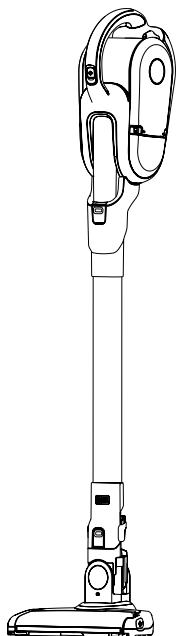

Operating instructions in the back

[www.blackanddecker.co.uk](http://www.blackanddecker.co.uk)

HVFE2150L  
HVFE2150LB  
HVFE2150LR

**Intended use**

Your Black & Decker Dustbuster® handheld vacuum cleaner has been designed for vacuum cleaning purposes. This appliance is intended for household use only.



Read all of this manual carefully before operating the appliance.

**Safety instructions**

**Warning! Read all safety warnings and all instructions.** Failure to follow the warnings and instructions listed below may result in electric shock, fire and/or serious injury.



**Warning!** When using battery-powered appliances, basic safety precautions, including the following, should always be followed to reduce the risk of fire, leaking batteries, personal injury and material damage.

- ◆ Read all of this manual carefully before using the appliance.
- ◆ The intended use is described in this manual. The use of any accessory or attachment or the performance of any operation with this appliance other than those recommended in this instruction manual may present a risk of personal injury.
- ◆ Retain this manual for future reference.

**Using your appliance**

- ◆ Do not use the appliance to pick up liquids or any materials that could catch fire.

- ◆ Do not use the appliance near water.
- ◆ Do not immerse the appliance in water.
- ◆ Never pull the charger lead to disconnect the charger from the socket. Keep the charger lead away from heat, oil and sharp edges.
- ◆ This appliance can be used by children aged from 8 years and above and persons with reduced physical, sensory or mental capabilities or lack of experience and knowledge if they have been given supervision or instruction concerning use of the appliance in a safe way and understand the hazards involved. Children shall not play with the appliance. Cleaning and user maintenance shall not be made by children without supervision.

**Inspection and repairs**

- ◆ Before use, check the appliance for damaged or defective parts. Check for breakage of parts, damage to switches and any other conditions that may affect its operation.
- ◆ Do not use the appliance if any part is damaged or defective.
- ◆ Have any damaged or defective parts repaired or replaced by an authorized repair agent.
- ◆ Regularly check the charger lead for damage. Replace the charger if the lead is damaged or defective.
- ◆ Never attempt to remove or replace any parts other than those specified in this manual.

## Additional safety instructions

### After use

- ◆ Unplug the charger before cleaning the charger or charging base.
- ◆ When not in use, the appliance should be stored in a dry place.
- ◆ Children should not have access to stored appliances.

### Residual risks.

Additional residual risks may arise when using the tool which may not be included in the enclosed safety warnings. These risks can arise from misuse, prolonged use etc.

Even with the application of the relevant safety regulations and the implementation of safety devices, certain residual risks can not be avoided. These include:

- ◆ Injuries caused by touching any rotating/moving parts.
- ◆ Injuries caused when changing any parts, blades or accessories.
- ◆ Injuries caused by prolonged use of a tool. When using any tool for prolonged periods ensure you take regular breaks.
- ◆ Impairment of hearing.
- ◆ Health hazards caused by breathing dust developed when using your tool (example:- working with wood, especially oak, beech and MDF.)

## Batteries and chargers

### Batteries

- ◆ Never attempt to open for any reason.
- ◆ Do not expose the battery to water.
- ◆ Do not expose the battery to heat.
- ◆ Do not store in locations where the temperature may exceed 40°C.
- ◆ Charge only at ambient temperatures between 10°C and 40°C.
- ◆ Charge only using the charger provided with the appliance. Using the wrong charger could result in an electric shock or overheating of the battery.
- ◆ When disposing of batteries, follow the instructions given in the section "Protecting the environment".
- ◆ Do not damage/deform the battery pack either by puncture or impact, as this may create a risk of injury and fire.
- ◆ Do not charge damaged batteries.
- ◆ Under extreme conditions, battery leakage may occur. When you notice liquid on the batteries carefully wipe the liquid off using a cloth. Avoid skin contact.
- ◆ In case of skin or eye contact, follow the instructions below.

**Warning!** The battery fluid may cause personal injury or damage to property. In case of skin contact, immediately rinse with water. If redness, pain or irritation occurs seek medical attention. In case of eye contact, rinse immediately with clean water and seek medical attention.

## Chargers

Your charger has been designed for a specific voltage. Always check that the mains voltage corresponds to the voltage on the rating plate.

**Warning!** Never attempt to replace the charger unit with a regular mains plug.

- ◆ Use your Black & Decker charger only to charge the battery in the appliance with which it was supplied. Other batteries could burst, causing personal injury and damage.
- ◆ Never attempt to charge nonrechargeable batteries.
- ◆ If the supply cord is damaged, it must be replaced by the manufacturer or an authorised Black & Decker Service Centre in order to avoid a hazard.
- ◆ Do not expose the charger to water.
- ◆ Do not open the charger.
- ◆ Do not probe the charger.
- ◆ The appliance/battery must be placed in a well ventilated area when charging.

## Electrical safety

### Symbols on the charger

 Read all of this manual carefully before using the appliance.

 This tool is double insulated; therefore no earth wire is required. Always check that the power supply corresponds to the voltage on the rating plate.

 Short circuit proof safety isolating transformer. The mains supply is electrically separated from the transformer output.



The charger automatically shuts off if the ambient temperature becomes too high. As a consequence the charger will be inoperable. The charging base must be disconnected from the mains supply and taken to an authorised service centre for repair.



The charging base is intended for indoor use only.

### Maintenance

Your Black & Decker cordless appliance has been designed to operate over a long period of time with a minimum of maintenance. Continuous satisfactory operation depends upon proper tool care and regular cleaning.

**Warning!** Before performing any maintenance on cordless appliances:

- ◆ Run the battery down completely if it is integral and then switch off.
- ◆ Unplug the charger before cleaning it. Your charger does not require any maintenance apart from regular cleaning.
- ◆ Regularly clean the ventilation slots in your appliance/charger using a soft brush or dry cloth.
- ◆ Regularly clean the motor housing using a damp cloth. Do not use any abrasive or solvent-based cleaner.

### Protecting the environment



Separate collection. This product must not be disposed of with normal household waste.

Should you find one day that your Black & Decker product needs replacement, or if it is of no further use to you, do not dispose of it with household waste. Make this product available for separate collection.



Separate collection of used products and packaging allows materials to be recycled and used again. Re-use of recycled materials helps prevent environmental pollution and reduces the demand for raw materials.

Local regulations may provide for separate collection of electrical products from the household, at municipal waste sites or by the retailer when you purchase a new product.

Black & Decker provides a facility for the collection and recycling of Black & Decker products once they have reached the end of their working life. To take advantage of this service please return your product to any authorised repair agent who will collect them on our behalf.



You can check the location of your nearest authorised repair agent by contacting your local Black & Decker office at the address indicated in this manual. Alternatively, a list of authorised Black & Decker repair agents and full details of our after-sales service and contacts are available on the Internet at: [www.2helpU.com](http://www.2helpU.com)

## Guarantee

Black & Decker is confident of the quality of its products and offers an outstanding guarantee. This guarantee statement is in addition to and in no way prejudices your statutory rights. The guarantee is valid within the territories of the Member States of the European Union and the European Free Trade Area.

If a Black & Decker product becomes defective due to faulty materials, workmanship or lack of conformity, within 24 months from the date of purchase, Black & Decker guarantees to replace defective parts, repair products subjected to fair wear and tear or replace such products to ensure minimum inconvenience to the customer unless:

- ◆ The product has been used for trade, professional or hire purposes;
- ◆ The product has been subjected to misuse or neglect;
- ◆ The product has sustained damage through foreign objects, substances or accidents;
- ◆ Repairs have been attempted by persons other than authorised repair agents or Black & Decker service staff.

To claim on the guarantee, you will need to submit proof of purchase to the seller or an authorised repair agent. You can check the location of your nearest authorised repair agent by contacting your local Black & Decker office at the address indicated in this manual. Alternatively, a list of authorised Black & Decker repair agents and full details of our after-sales service and contacts are available on the Internet at: [www.2helpU.com](http://www.2helpU.com)

Please visit our website [www.blackanddecker.co.uk](http://www.blackanddecker.co.uk) to register your new Black & Decker product and to be kept up to date on new products and special offers. Further information on the Black & Decker brand and our range of products is available at [www.blackanddecker.co.uk](http://www.blackanddecker.co.uk)

### Do not forget to register your product!

[www.blackanddecker.co.uk/productregistration](http://www.blackanddecker.co.uk/productregistration) Register your product online at [www.blackanddecker.co.uk/productregistration](http://www.blackanddecker.co.uk/productregistration) or send your name, surname and product code to Black & Decker in your country.



Weight	kg	0.38	0.38	0.38
Approximate charge time	h	4	4	4
Current	mA	500	500	500
Output voltage	V <sub>dc</sub>	27.2	27.2	27.2
Input voltage	V <sub>dc</sub>	220-240	220-240	220-240
Charger		ETPCA-276050WV	ETPCA-276050WV/ ETPCA-276050WB	ETPCA-276050WV/ ETPCA-276050WB

Weight	kg	2.84	2.84	2.84
Battery	Typ.	Li-ion	Li-ion	Li-ion
Voltage	V <sub>dc</sub>	21.6	21.6	21.6
		(H1)	(H1)	(H1)
		HVFE2150L	HVFE2150LB	HVFE2150LR

## Technical data

LED patterns		LED patterns	
		Battery hot ■ ■ ■ ■ ■ ■ ■ ■ ■ ■	Allow to cool before continuing.
Solution	Solution	LED Pattern : charging ■ ■ ■ ■ ■ ■ ■ ■ ■ ■	Battery fault - Ensure correct charger is being used. Retry charging procedure. If fault continues, return unit to an authorised Black & Decker service centre.
		Charger fault ■ ■ ■ ■ ■ ■ ■ ■ ■ ■	
<b>Troubleshooting</b>			

This tool includes some or all of the following features.

1. On/off power switch
2. Handle
3. Nozzle
4. Pull out crevice tool
5. LED charging indicator
6. Dust bowl door
7. Dust bowl
8. Brush tool
9. Floor extension release clip
10. Floor extension tube
11. Floor head release clip
12. Flip down brush
13. Floor head
14. Charging base

### Wall Mounting

The charging base can be attached to a wall to provide a convenient storage and charging point for the appliance. When fixing to a wall, make sure that the fixing method is suitable for the wall type and is appropriate to the weight of the appliance.

- ◆ Mark the location of the screw holes (within reach of an electrical outlet for charging the vac while it is on the wall bracket).
- ◆ Insert the charger cord into the curved slot in the wall mount bracket leaving approximately 20 cm excess.
- ◆ Mount the charger on the wall by placing the opening on the base of the vac over the hooks in the wall mount bracket.

### Battery



There are no user serviceable part inside. For safe recycling of the battery and internal components please return the unit to an authorised Black&Decker service centre.

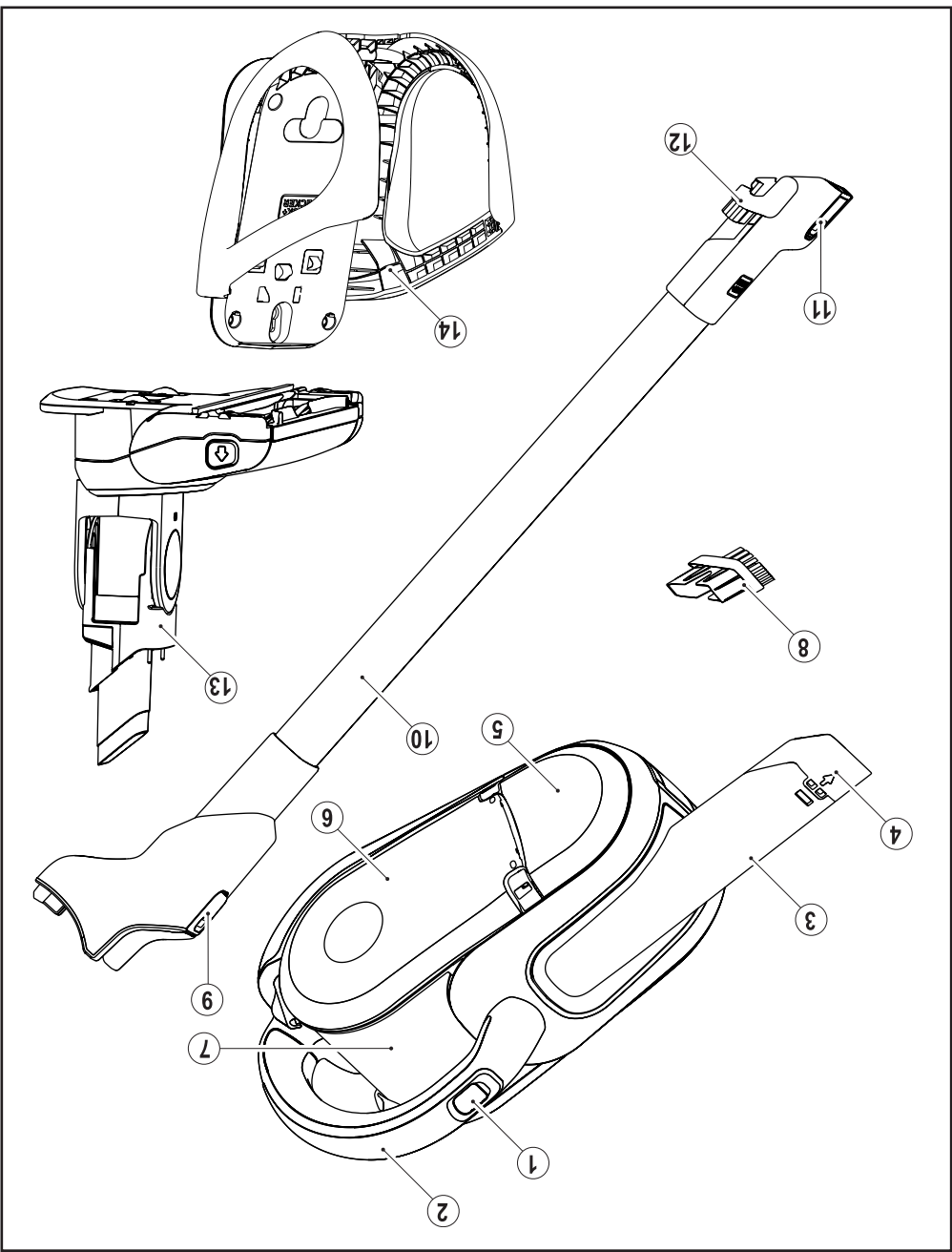

Features

Dry thoroughly

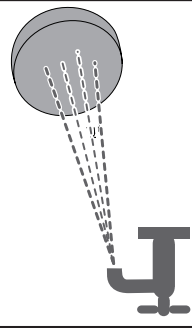

5

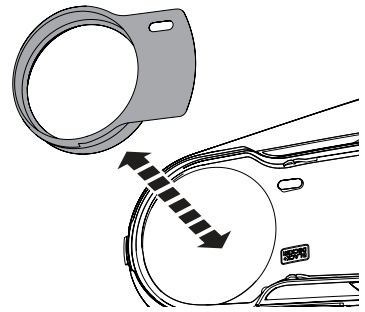

Wipe with cloth or soft dry brush

3

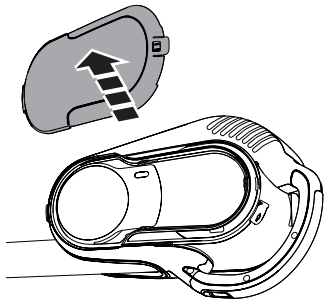

4

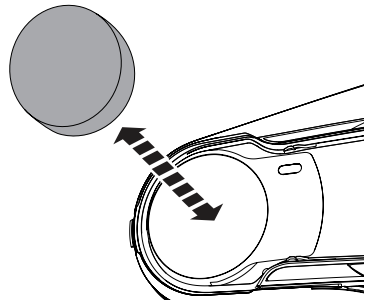

1

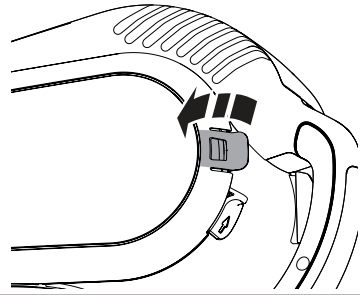

2

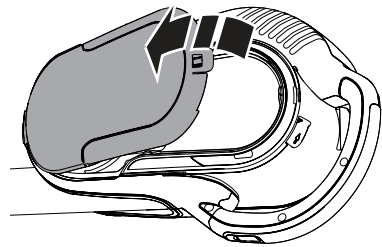

Clean exhaust filter

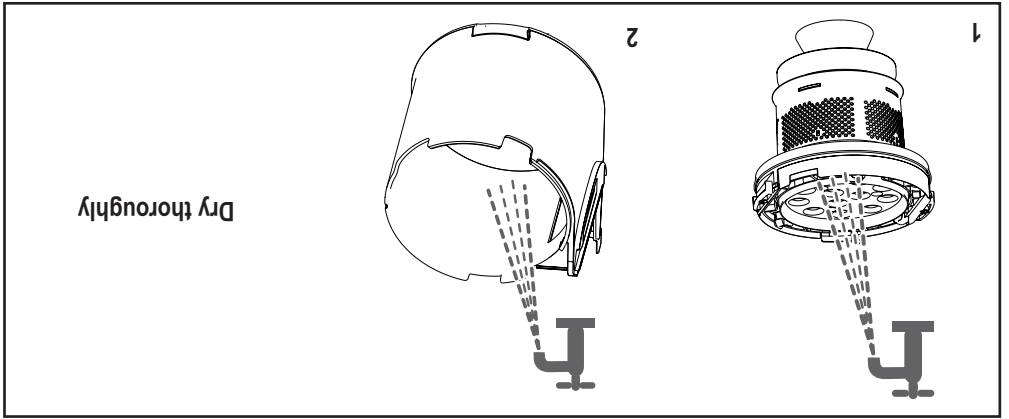

**Wash**

Re-assemble after cleaning the filter or continue to wash.



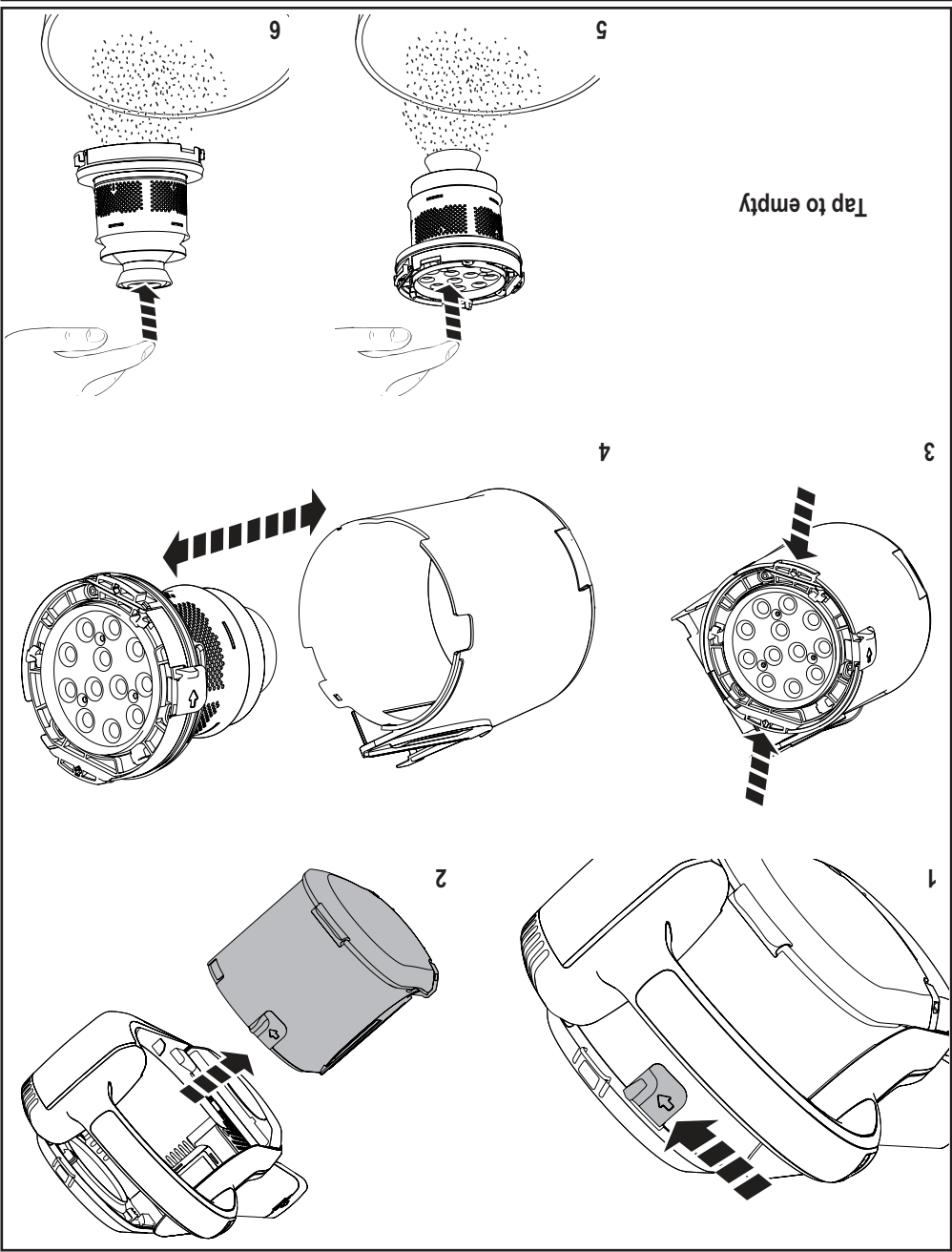

Clean cyclonic filter



In order to keep the suction force optimised, the filters must be cleared regularly during use.

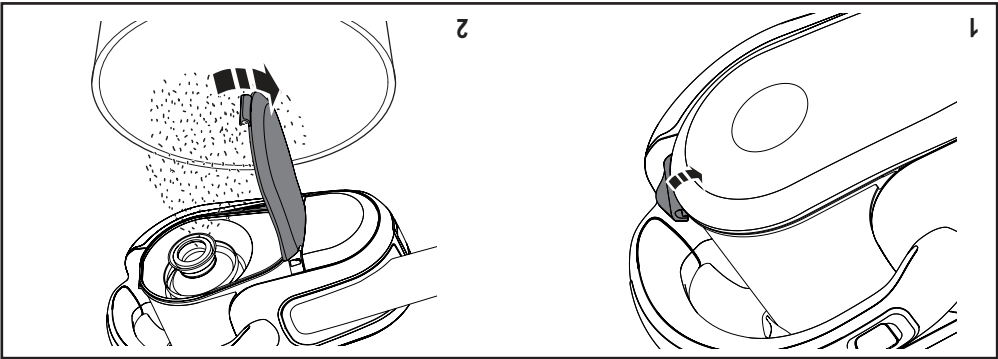
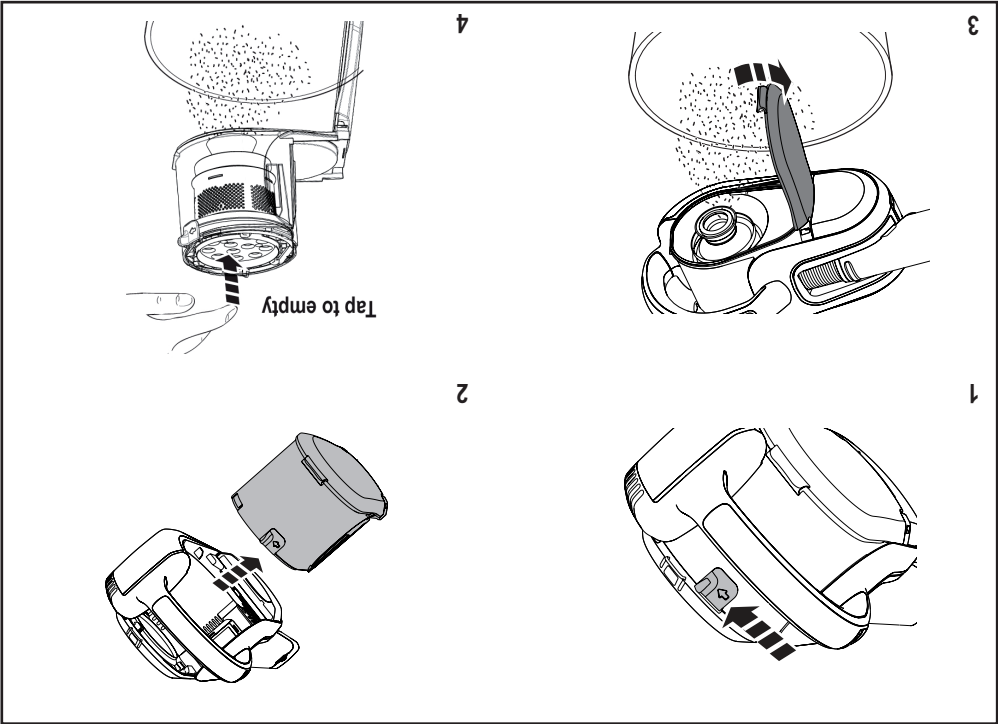

# Emptying

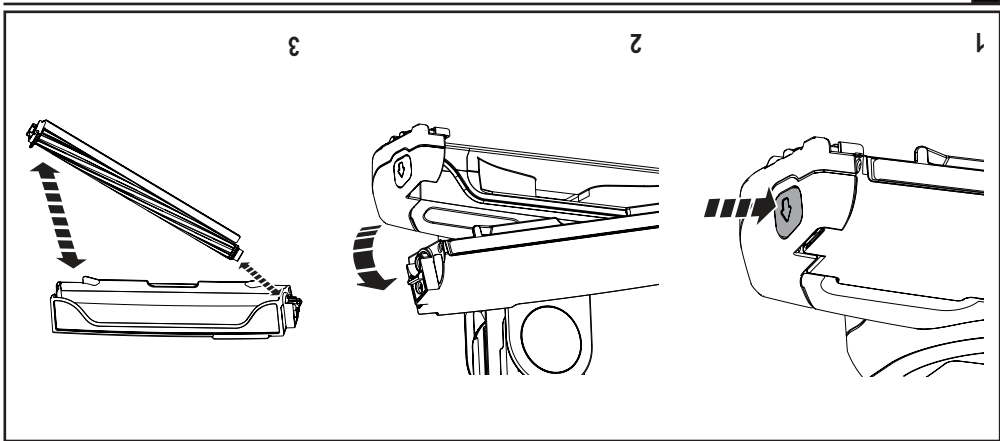

Clean floor head

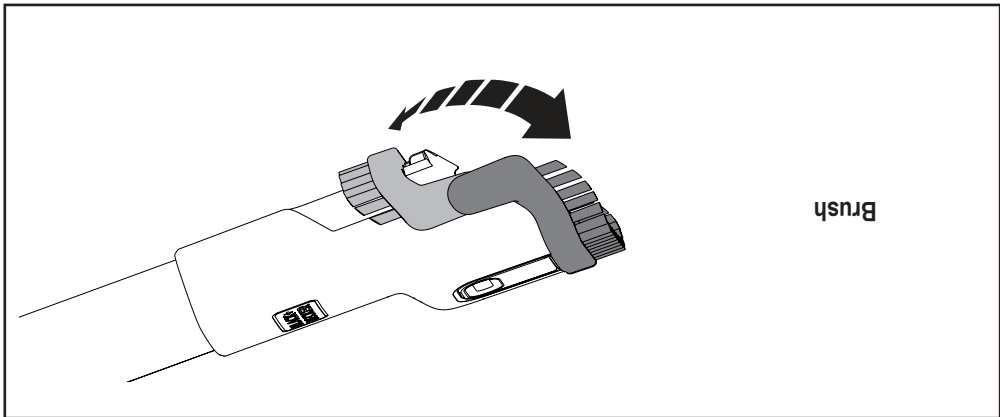
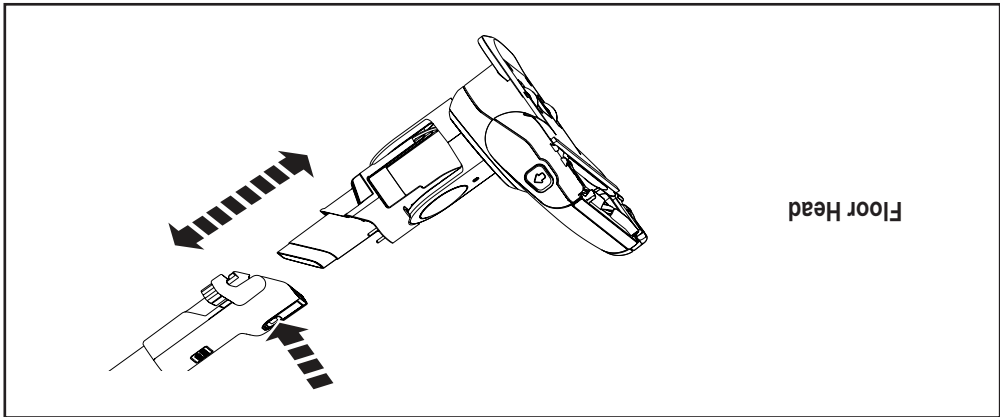

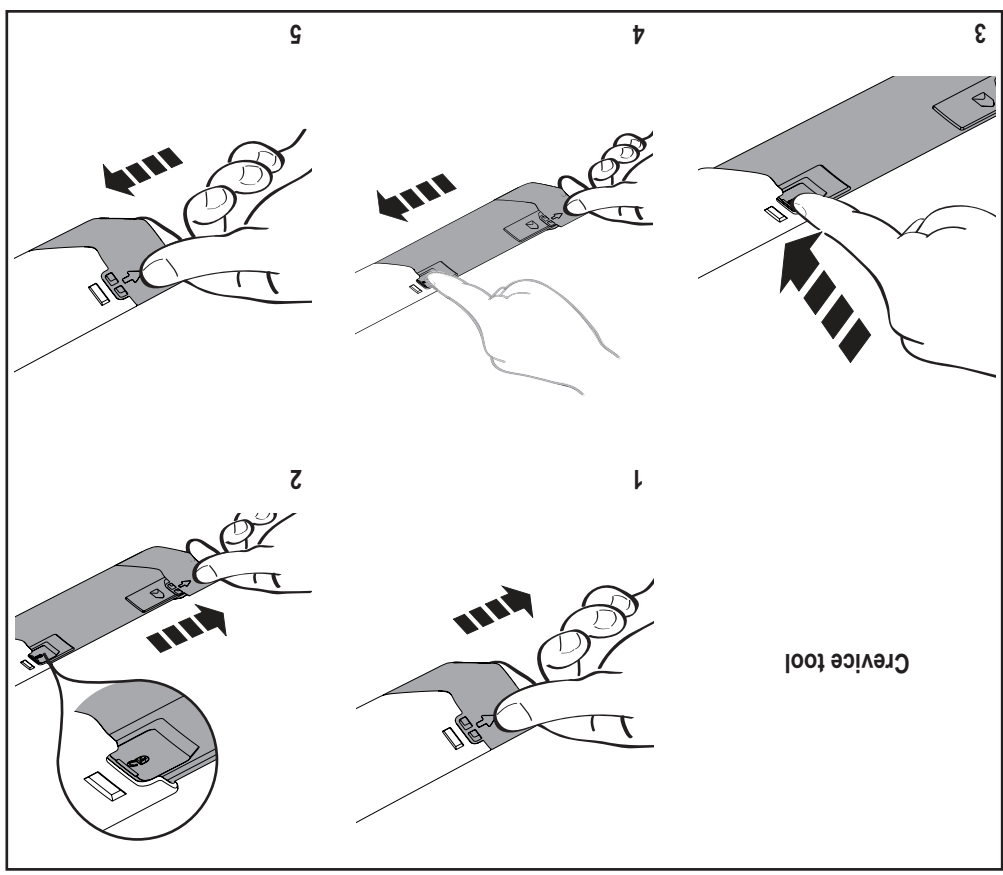
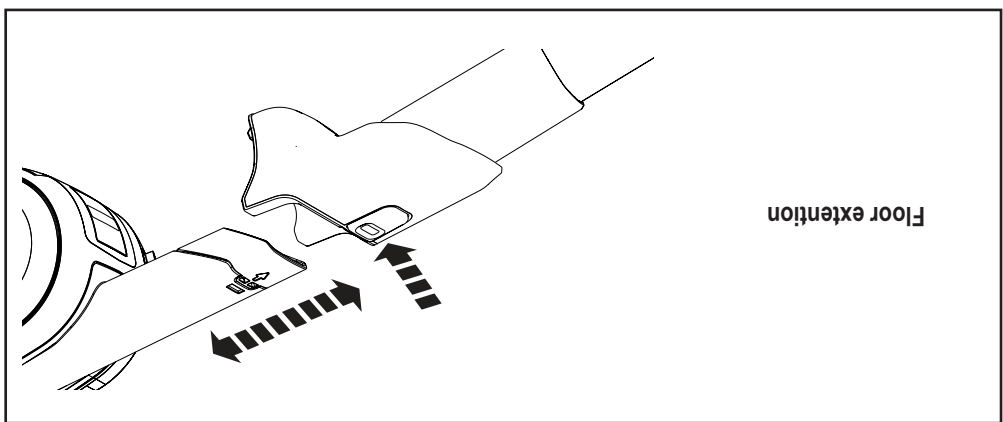

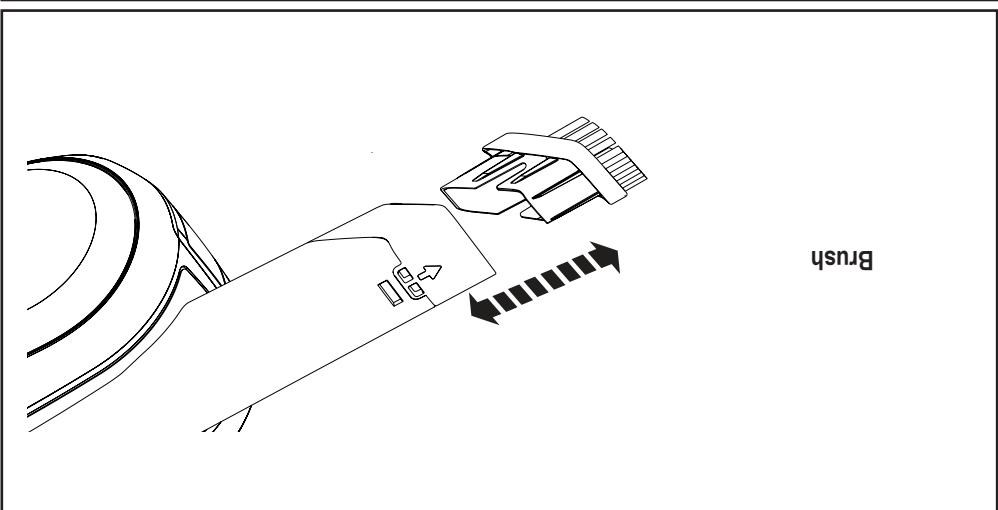

Brush

### Accessories



Battery empty



Battery low



For battery charge, level, LED's illuminate the same as when charging



### LED patterns

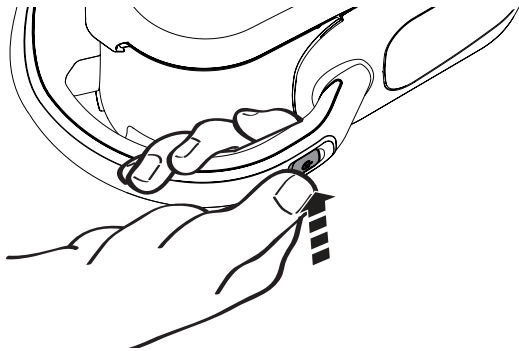

On

NO

The appliance can be left connected to the charger and may become warm during use.



The light will go out when charging is complete.



LED patterns

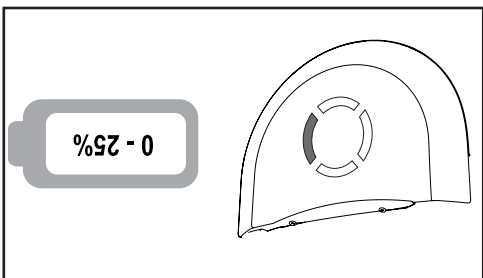
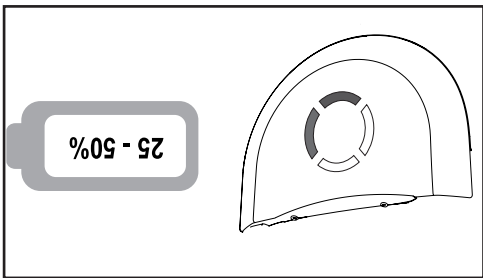
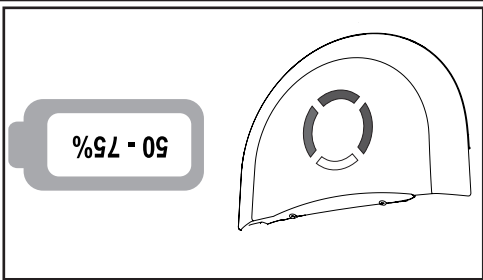
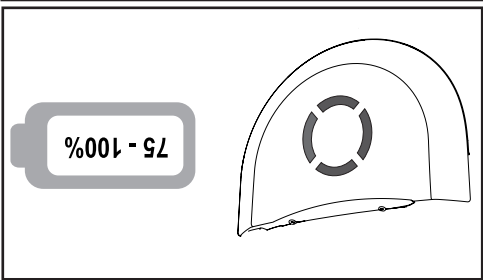

LED patterns

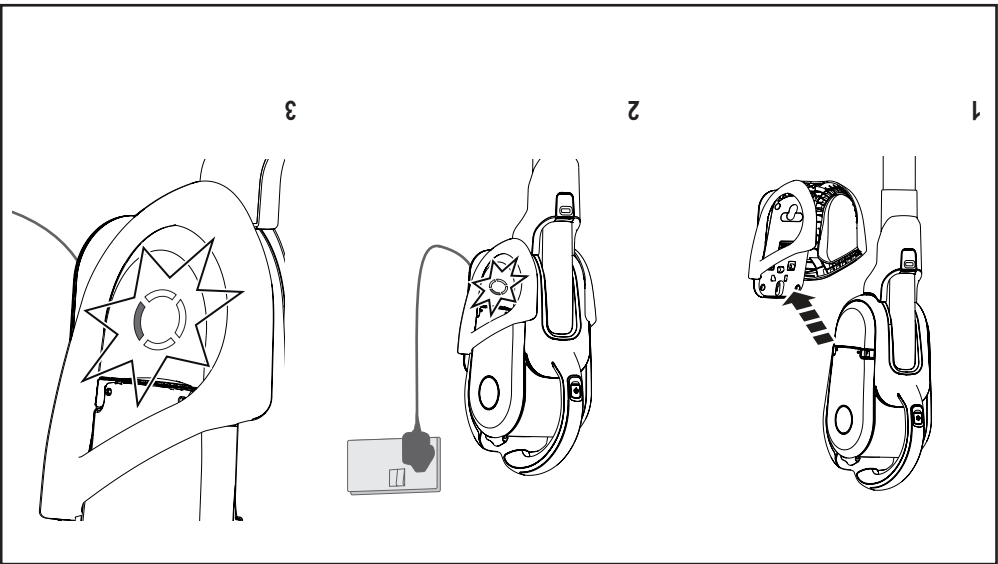

Charging

# Operating Instructions